



FORT

ECSPST

Fort Programmable Thermostat
with RF and WiFi



QUICK START GUIDE

Contents

Features	Page 2
Product Overview	Page 3
Thermostat Functions	Page 4
Thermostat Configuration	Page 5
Thermostat Installation	Page 6
Installation Plan A	Page 7
Installation Plan B	Page 8
Pairing the Thermostat and Receiver	Page 9
Product Description, Preparation for use & Installation Instructions	Page 10

Features

- Large LED display
- Touch button
- Permanent user settings, and program settings during power loss
- One button 'Holiday' mode
- Programming Periods;
- 7 Day individual, 5/2 split (Monday - Friday, Saturday & Sunday)
- 6 Separate time/temperature periods per day
- Key lock facility
- Low battery indication
- Frost protection
- Optional Intelligent function; Optimal Start
- Open window function
- Integrated with Clicksmart+ App

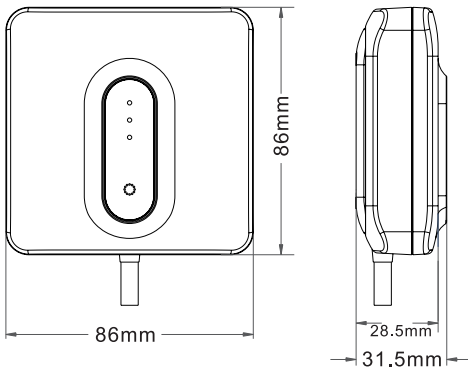



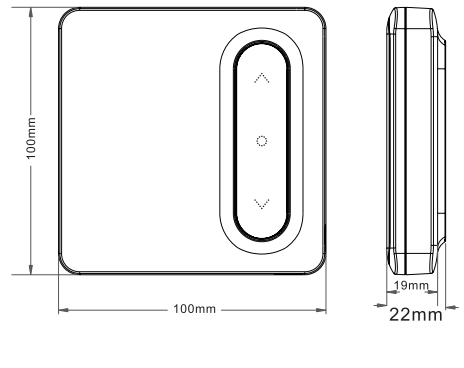







Receiver



Thermostat

Product Overview

Thermostat

1.  Wireless icon ' ' always on when paired with the receiver, flashes when connection is intermittent
2.  Frost protection icon
3.  Call for heat icon
4.  Programming mode icon
5.  Low battery alert
6.  Confirm icon
7.  Up button
8.  ON/OFF button
9.  Room temperature or setting temperature display
10.  Down button

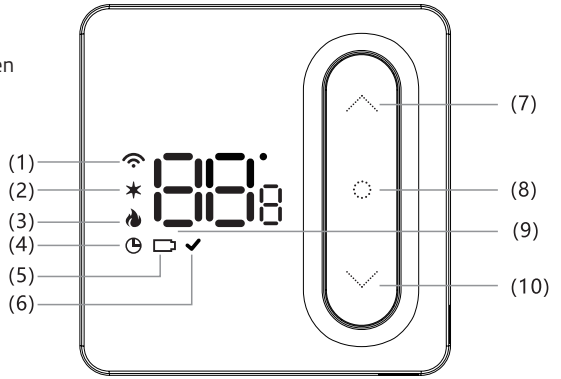

Receiver

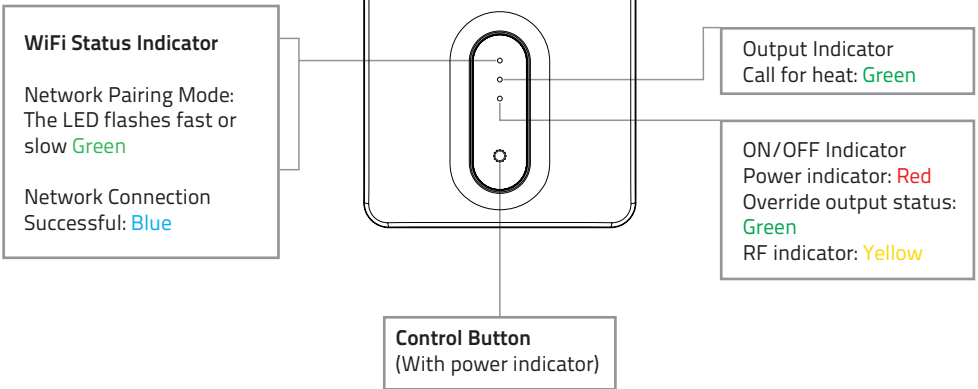

* To manually call for heat, press and hold the control button, until the LED turns **Green**.

Default Programming Schedule

Note: The programming schedule can be configured within the ClickSmart+ app

Period 1		Period 2		Period 3		Period 4		Period 5		Period 6	
Morning ON		Morning OFF		Afternoon ON		Afternoon OFF		Evening ON		Evening OFF	
06:00	20°C	08:00	16°C	11:00	20°C	14:00	16°C	18:00	20°C	22:00	16°C

Thermostat Functions

Functions

Switching between ON & Standby modes

Press "⊙" to turn the Thermostat into the ON mode. Press and hold "⊙" again to switch the thermostat into standby mode. When in standby mode the Thermostat will display "⊙F".

Note: When in standby mode, only frost protection is active on the thermostat.

Key Lock Function

In main display interface, press and hold "∨" "∧" at the same time to lock or unlock the keys. When locked, the thermostat will display "LK".

Frost Protection

If the room temperature falls below 5°C, frost damage can occur. To protect your home, the Thermostat once it detects the ambient temperature is below 5°C will send a Call for heat, until the temperature is above 8°C, and will then end the Call for heat. This is indicated by a "★" icon.

*This feature can be disabled in the configuration menu

Open Window/Door Detection Function

If the room temperature drops 1.5°C in 3 minutes, this function will activate and display "[]", then turn down all heating. When the room temperature increases by 1.5°C or after 30 minutes, the thermostat will return to normal operation. Press any button to cancel this function when it is active.

Low Power Alert

When the thermostat is critically low on power, it will alert the user by displaying "□" to notify them to change the batteries.

Optimal Start

If optimal start is enabled, the thermostat will start the call for heat slightly before the schedule calls for it. So that by the scheduled start time, the ambient temperature is already at the set temperature.

*This feature can be enabled in the configuration menu

Fault

If there is damage to the internal sensor the user will be alerted by the display message "Er".

Operating Modes

Schedule Mode

The thermostat will run according to the set schedule, the screen will display a solid "⊙" icon.

Boost Mode

The boost mode, will send a call for heat until the next program in the schedule and will continue to send the call for heat until the set temperature is achieved.

When in schedule mode (indicated by a solid "⊙" icon), press the "∨" or "∧" and set the desired temperature, the Thermostats display will flash to indicate it is activating the boost mode.

When a boost is currently active it will display the "⊙" icon flashing.

Manual Mode

The 'Manual' mode sets the thermostat to the desired temperature and will continue to do so until, the user ends the Manual mode.

Pressing "⊙" will toggle between Schedule mode & Manual Mode. The Thermostat will indicate it is in Manual mode by not displaying the "⊙" icon.

Thermostat Configuration

To configure the thermostat using its controls you will need to do the following:

- (1) In standby mode indicated by the Thermostat displaying "OFF", long press "⊙" to enter the configuration menu.
- (2) The first item will display "CL", press "⊙" to enter the configuration for the first item.
- (3) You can adjust the setting by pressing "▼" or "▲".
- (4) "✓" will flash, and then press "⊙" will save current settings, and exit to the configuration menu.
- (5) Use the "▼" or "▲" to select the configuration menu, and then press "⊙" to enter the next configuration, and follow the steps **3 & 4**.
- (6) Finally once all menus have been configured, long press "⊙" to save and exit the configuration menu.

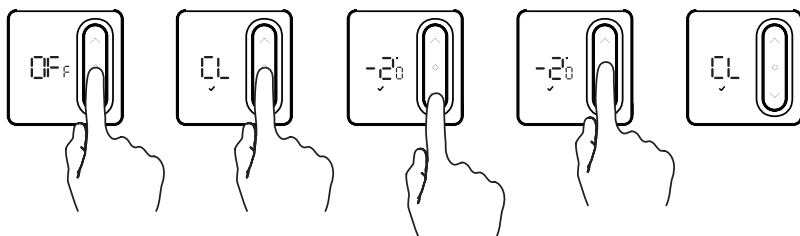

Restore factory settings:

After entering the configuration menu, press and hold both the "▼" and "▲" buttons, to restore the thermostat to factory settings, the thermostat will display "OFF" and flash 3 times.

This will remove any custom configuration setting(s) and programming setting(s)

Step No.	Displayed (Factory Default)	Press "▼" or "▲" to select	Descriptions
1	CL (00)	-4°C to +4°C	Temperature calibration
2	RH (30)	+20°C to +35°C	Select maximum setting temperature range
3	RL (05)	+5°C to +20°C	Select minimum setting temperature range
4	db (0)	0.5°C to 3°C	Start heating conditions: When setting temperature - Room temperature ≥ 0.5°C (0.5-3°C option), start heating. Room temperature ≥ Setting temperature, stop heating.
5	SE ₃ (6)	4 / 6	Number of programming periods per day; 2 ON & 2 OFFs / 3 ON & 3 OFFs
6	ES (OFF)	ON / OFF	Intelligent function (Optimal start)
7	PP (OFF)	ON / OFF	Frost Protection function
8	RY (OFF)	ON / OFF	Thermostat Relay Output
9	SH (ON)	ON / OFF	Thermostat LED Display option ON: LEDs displays on Thermostat VIA app. OFF: LEDs don't display on Thermostat VIA app. OFF: LED lights

Thermostat Installation

Battery Installation

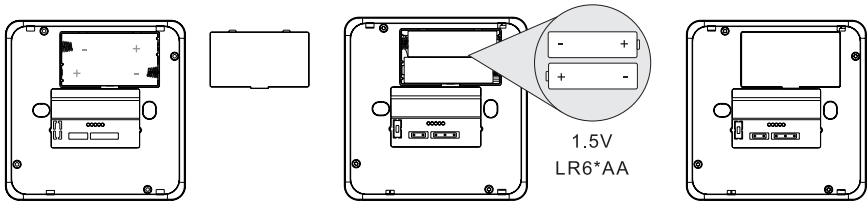

1. Take off cover

2. Install AA Batteries

3. Complete Installation

Note: Ensure the batteries are correctly installed, and the polarities are correctly aligned.

1. Desk mounted

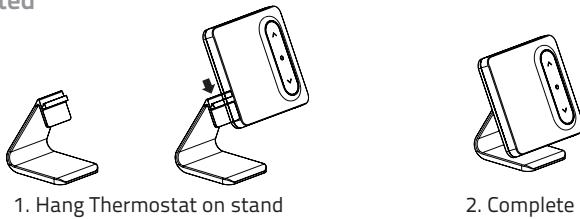

1. Hang Thermostat on stand

2. Complete

2. Wall mounted

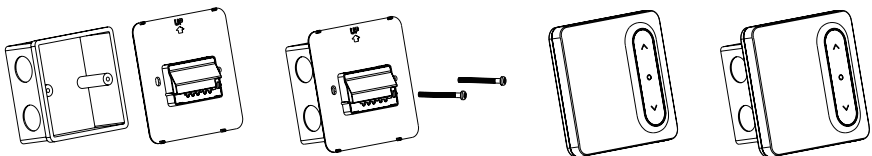

1. Put the back board on the installation box

2. Secure backplate to installation box using bolts

3. Secure thermostat to backplate

4. Complete



Elite Security Products
Unit 7, Target Park, Shawbank Rd
Lakeside, Redditch B98 8YN



● ● ● ● ● **Scolmore**GROUP

www.espuk.com

E&OE - Errors and Omissions
Excepted. K23

Telephone: 01527 51 51 50
Fax: 01527 51 51 43
email: sales@espuk.com