



FORT

ECSPST

Fort Programmable Thermostat
with RF and WiFi



USER MANUAL

Contents

Features	Page 2
Product Overview	Page 3
Thermostat Functions	Page 4
Thermostat Configuration	Page 5
Thermostat Installation	Page 6
Installation Plan A	Page 7
Installation Plan B	Page 8
Pairing the Thermostat and Receiver	Page 9
Product Description, Preparation for use & Installation Instructions	Page 10
How to intergrate the ECSPST into Alexa	Page 11
How to intergrate the ECSPST into Google Home	Page 12
Voice Commands	Page 13
Notes	Page 14

Features

- Large LED display
- Touch button
- Permanent user settings, and program settings during power loss
- One button 'Holiday' mode
- Programming Periods;
- 7 Day individual, 5/2 split (Monday - Friday, Saturday & Sunday)
- 6 Separate time/temperature periods per day
- Key lock facility
- Low battery indication
- Frost protection
- Optional Intelligent function; Optimal Start
- Open window function
- Integrated with Clicksmart+ App

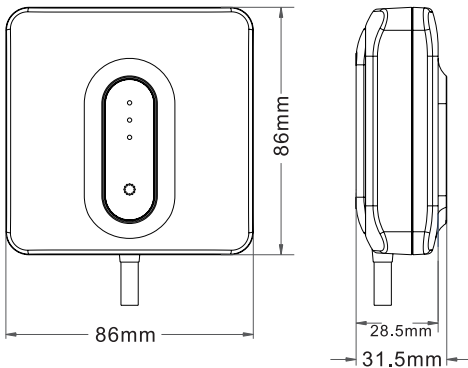



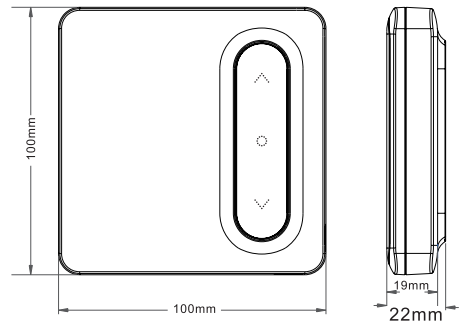







Receiver



Thermostat

Product Overview

Thermostat

1.  Wireless icon ' ' always on when paired with the receiver, flashes when connection is intermittent
2.  Frost protection icon
3.  Call for heat icon
4.  Programming mode icon
5.  Low battery alert
6.  Confirm icon
7.  Up button
8.  ON/OFF button
9.  Room temperature or setting temperature display
10.  Down button

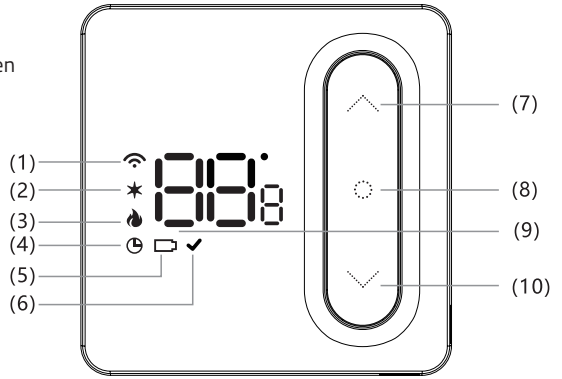

Receiver

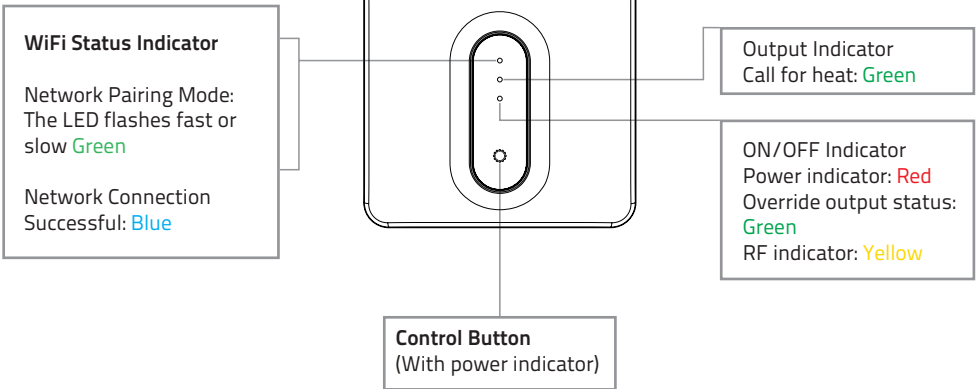

* To manually call for heat, press and hold the control button, until the LED turns **Green**.

Default Programming Schedule

Note: The programming schedule can be configured within the ClickSmart+ app

Period 1	Period 2	Period 3	Period 4	Period 5	Period 6
Morning ON	Morning OFF	Afternoon ON	Afternoon OFF	Evening ON	Evening OFF
06:00 20°C	08:00 16°C	11:00 20°C	14:00 16°C	18:00 20°C	22:00 16°C

Thermostat Functions

Functions

Switching between ON & Standby modes

Press "⊙" to turn the Thermostat into the ON mode. Press and hold "⊙" again to switch the thermostat into standby mode. When in standby mode the Thermostat will display "⊙F".

Note: When in standby mode, only frost protection is active on the thermostat.

Key Lock Function

In main display interface, press and hold "∨" "∧" at the same time to lock or unlock the keys. When locked, the thermostat will display "LK".

Frost Protection

If the room temperature falls below 5°C, frost damage can occur. To protect your home, the Thermostat once it detects the ambient temperature is below 5°C will send a Call for heat, until the temperature is above 8°C, and will then end the Call for heat. This is indicated by a "★" icon.

*This feature can be disabled in the configuration menu

Open Window/Door Detection Function

If the room temperature drops 1.5°C in 3 minutes, this function will activate and display "[]", then turn down all heating. When the room temperature increases by 1.5°C or after 30 minutes, the thermostat will return to normal operation. Press any button to cancel this function when it is active.

Low Power Alert

When the thermostat is critically low on power, it will alert the user by displaying "□" to notify them to change the batteries.

Optimal Start

If optimal start is enabled, the thermostat will start the call for heat slightly before the schedule calls for it. So that by the scheduled start time, the ambient temperature is already at the set temperature.

*This feature can be enabled in the configuration menu

Fault

If there is damage to the internal sensor the user will be alerted by the display message "Er".

Operating Modes

Schedule Mode

The thermostat will run according to the set schedule, the screen will display a solid "⊙" icon.

Boost Mode

The boost mode, will send a call for heat until the next program in the schedule and will continue to send the call for heat until the set temperature is achieved.

When in schedule mode (indicated by a solid "⊙" icon), press the "∨" or "∧" and set the desired temperature, the Thermostats display will flash to indicate it is activating the boost mode.

When a boost is currently active it will display the "⊙" icon flashing.

Manual Mode

The 'Manual' mode sets the thermostat to the desired temperature and will continue to do so until, the user ends the Manual mode.

Pressing "⊙" will toggle between Schedule mode & Manual Mode. The Thermostat will indicate it is in Manual mode by not displaying the "⊙" icon.

Thermostat Configuration

To configure the thermostat using its controls you will need to do the following:

- (1) In standby mode indicated by the Thermostat displaying "OFF", long press "ⓘ" to enter the configuration menu.
- (2) The first item will display "CL", press "ⓘ" to enter the configuration for the first item.
- (3) You can adjust the setting by pressing "▼" or "▲".
- (4) "✓" will flash, and then press "ⓘ" will save current settings, and exit to the configuration menu.
- (5) Use the "▼" or "▲" to select the configuration menu, and then press "ⓘ" to enter the next configuration, and follow the steps **3 & 4**.
- (6) Finally once all menus have been configured, long press "ⓘ" to save and exit the configuration menu.

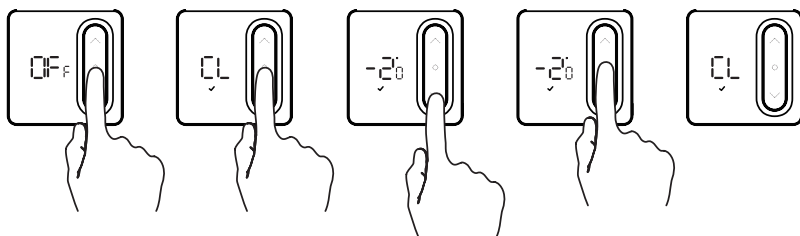

Restore factory settings:

After entering the configuration menu, press and hold both the "▼" and "▲" buttons, to restore the thermostat to factory settings, the thermostat will display "OFF" and flash 3 times.

This will remove any custom configuration setting(s) and programming setting(s)

Step No.	Displayed (Factory Default)	Press "▼" or "▲" to select	Descriptions
1	CL (00)	-4°C to +4°C	Temperature calibration
2	RH (30)	+20°C to +35°C	Select maximum setting temperature range
3	RL (05)	+5°C to +20°C	Select minimum setting temperature range
4	dt (0)	0.5°C to 3°C	Start heating conditions: When setting temperature - Room temperature ≥ 0.5°C (0.5-3°C option), start heating. Room temperature ≥ Setting temperature, stop heating.
5	SE ₃ (6)	4 / 6	Number of programming periods per day; 2 ON & 2 OFFs / 3 ON & 3 OFFs
6	ES (OFF)	ON / OFF	Intelligent function (Optimal start)
7	PP (OFF)	ON / OFF	Frost Protection function
8	RY (OFF)	ON / OFF	Thermostat Relay Output
9	SH (ON)	ON / OFF	Thermostat LED Display option ON: LEDs displays on Thermostat VIA app. OFF: LEDs don't display on Thermostat VIA app. OFF: LED lights

Thermostat Installation

Battery Installation

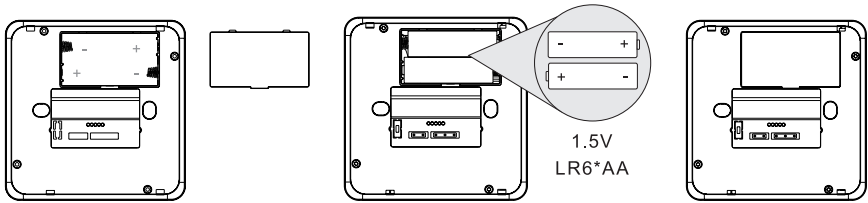

1. Take off cover

2. Install AA Batteries

3. Complete Installation

Note: Ensure the batteries are correctly installed, and the polarities are correctly aligned.

1. Desk mounted

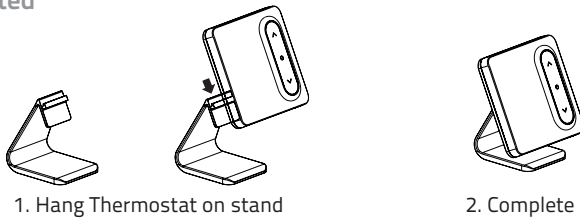

1. Hang Thermostat on stand

2. Complete

2. Wall mounted

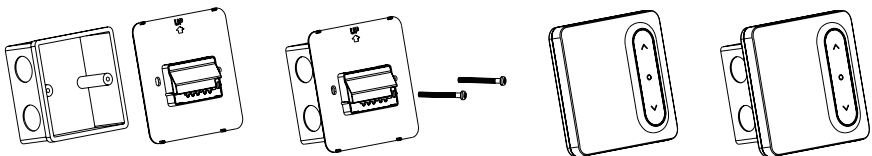

1. Put the back board on the installation box

2. Secure backplate to installation box using bolts

3. Secure thermostat to backplate

4. Complete

Installation Plan A

Our products are designed to comply with the recommended codes of practice and is to be installed and serviced by competent persons in accordance with the relevant wiring regulations.



Warning: Before any installation or maintenance, ensure that the electrical supply is switched off at the breaker.

The receiver needs to be installed in the boiler's vicinity, and within the desired wireless networks signal area. The Thermostat can be installed anywhere within range of the receiver.

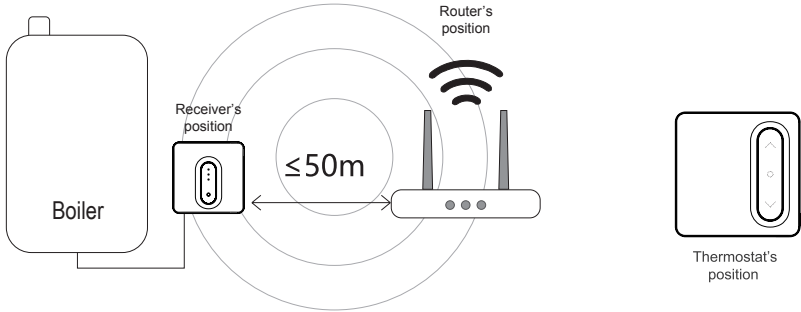

Note: Distance between thermostat and receiver cannot be greater than 100m (open field).

1. Install receiver on the wall

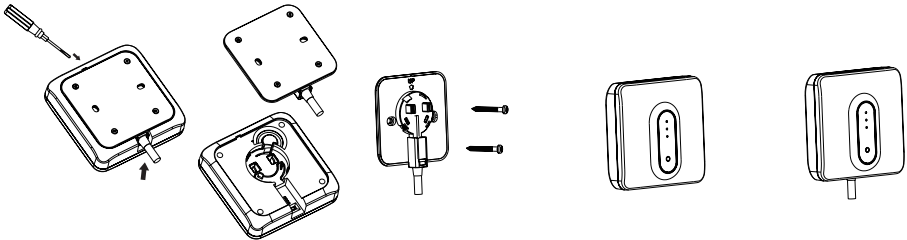

1. Open backplate from the top
2. Install the backplate onto the wall.
3. Clip the receiver onto the backplate
4. Complete

2. Installation Plan A Wiring

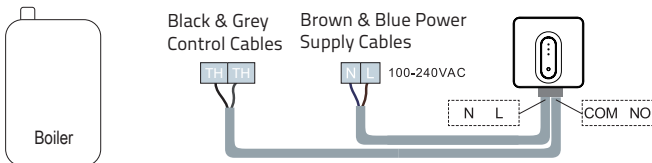

1. Potential Free Relay

Boiler type selection;
The Thermostats output between N/C & N/O,
Typically N/O

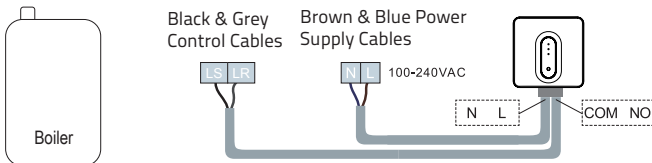
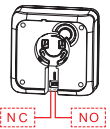

2. 230V Relay

Boiler type selection;
This boiler type can only be N/O

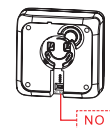

Installation Plan B

Our products are designed to comply with the recommended codes of practice and is to be installed and serviced by competent persons in accordance with the relevant wiring regulations.



Warning: Before any installation or maintenance, ensure that the electrical supply is switched off at the breaker.

When installing the Thermostat directly to the boiler, ensure the receiver is within the WiFi coverage area.

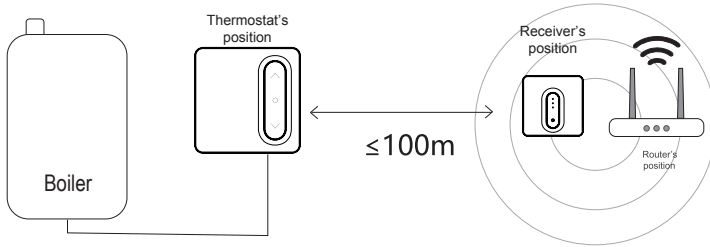

Note: Distance between thermostat and receiver cannot be greater than 100m (open field).

When the Thermostat is connected directly to the boiler, item 8 of the configuration should be "ON" [Page 5]. As default it is set to OFF

1. Install receiver as gateway with plug adapter

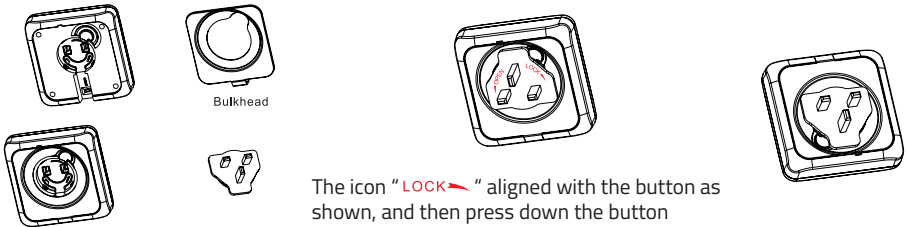

The icon "LOCK" aligned with the button as shown, and then press down the button

1. Install rear bulkhead

2. Press and rotate to clip in the adapter

3. Complete

2. Installation Plan B Wiring



1. Remove the buckle with a flat headed screwdriver



2. Take off safety cover

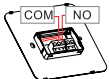

3. Wire into connections



4. Reinstall safety cover

Caution: potential of 230V on connection. Risk of electric shock

1. Potential Free Relay Black & Grey Control Cables



If NC is required, terminate into COM & NC



2. 230V Relay



Black & Grey Control Cables



Pairing the Thermostat and Receiver

As default, the Thermostat & Receiver are pre-paired

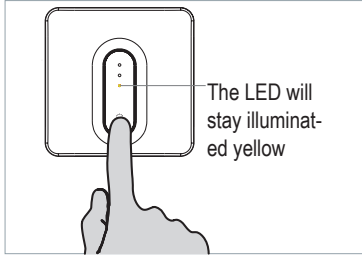

1. Press "⏻" to turn off the receiver, when in the OFF condition, press and hold the "⏻" button for at least 3 seconds, the LED will now illuminate yellow constantly.

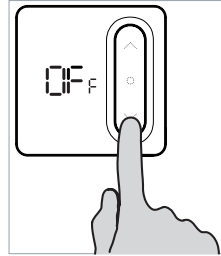

2. On the Thermostat when in "Standby" mode, press and hold "⏻" for 3s.

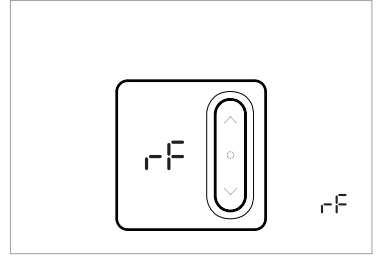

3. The Thermostat will then show "rF".

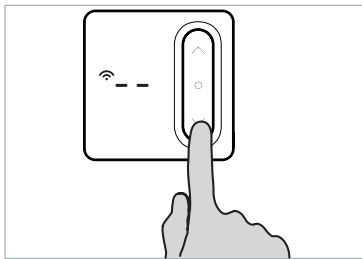

4. On the Thermostat: Press the "⏻" to enter pairing mode, it will display "--", and the icon "📶" will be flashing.

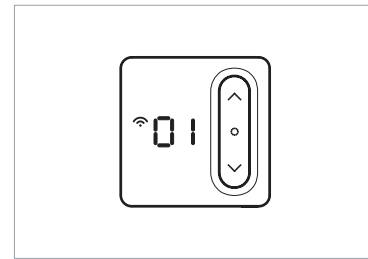

5. If pairing is successful, the Thermostat will display "01", and the "📶" icon will now constantly display, and then will automatically go back into the OFF interface.

Product Description

The WiFi Smart Thermostat (ECSPST) forms part of the ESP Fort range of smart products, and can also be used in conjunction with Scolmores ClickSmart+ range of products.

Users are able to control the Smart Thermostat using the ClickSmart+ app, manually and using voice controls (once correctly configured).

The ECSPST can be used to program your heating schedule, and the desired heating temperature.

Preparation for use

To use the ECSPST you will need to download the ClickSmart+ app. Ensure that you have a mobile device running iOS 8 or higher, or Android 4.1x or higher, and a sufficient WiFi network connection.

It is important to know your Wi-Fi network and W-Fi network's password before pairing the Thermostat to the ClickSmart+ app.



Download the ClickSmart+ App on your mobile device from the App Store or Google Play.

You can scan the above QR code to directly download the app

Sign in or register following the instructions on the ClickSmart+ App.

Installation Instructions

1. On the ClickSmart+ app's home page, click on the "+" symbol in the top right of the home screen.
2. Then click on "ESP" on the left handside.
3. And finally click on "Smart WiFi Thermostat with RF"
4. The app will then display on screen instructions for pairing the ECSPST onto the Wi-Fi network.

How to integrate the ECPST into Alexa

Once the ECPST has been configured with the ClickSmart+ App, you can then control the thermostat using voice commands.

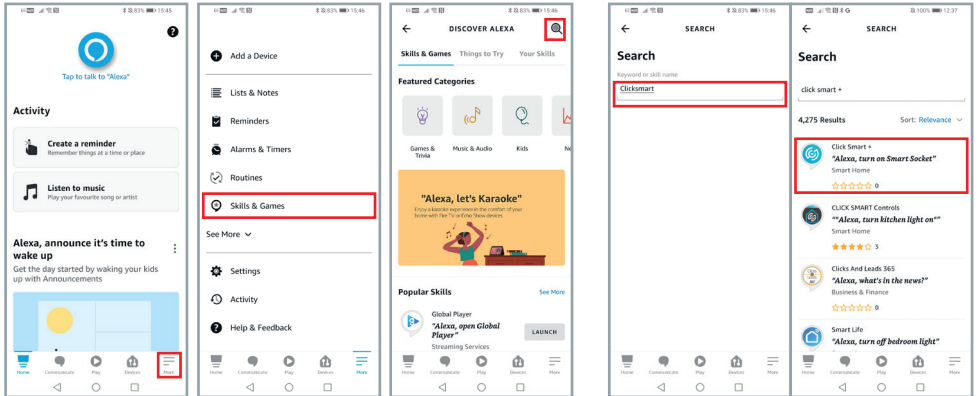

1. Open the Alexa app, and press "More" on the bottom task bar

2. Press "Skills & Games"

3. Press the magnifying glass

4. Search for "Click Smart +", and click on "Click Smart +"

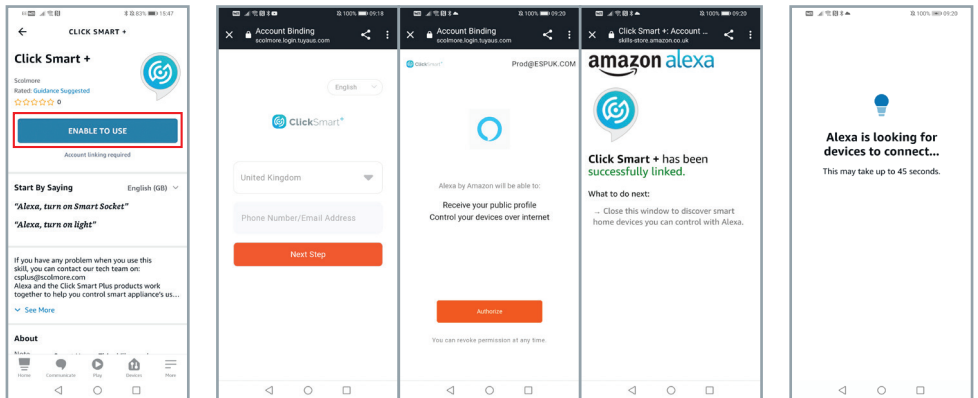

5. Press "ENABLE TO USE"

6. The Alexa app will then take you through the Account Binding Process, you must use the ClickSmart+ Account you used to pair your ECPST

7. Alexa will start searching for Alexa Voice compatible Click Smart + products.

How to integrate the ECPST into Google Home

Once the ECPST has been configured with the ClickSmart+ App, you can then control the thermostat using voice commands.

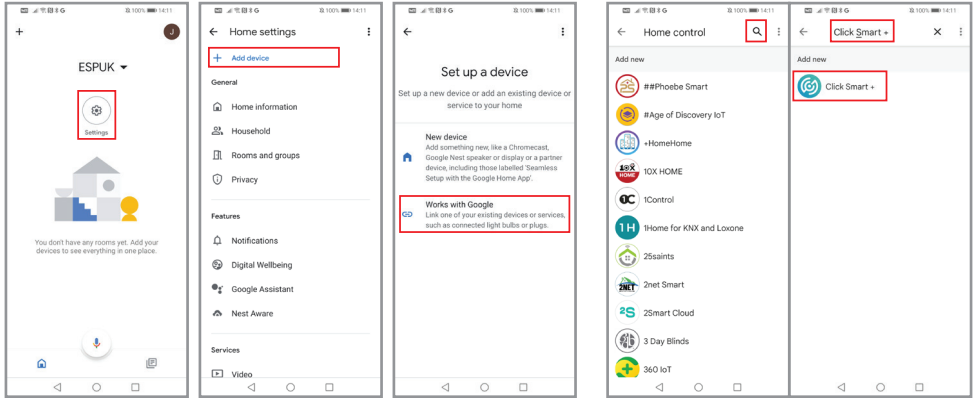

1. Open the Google Home app and press "settings"

2. Press "Add Device"

3. Press "Works with Google"

4. Press on the magnifying glass, then search for "Click Smart +", and finally click onto "Click Smart +"

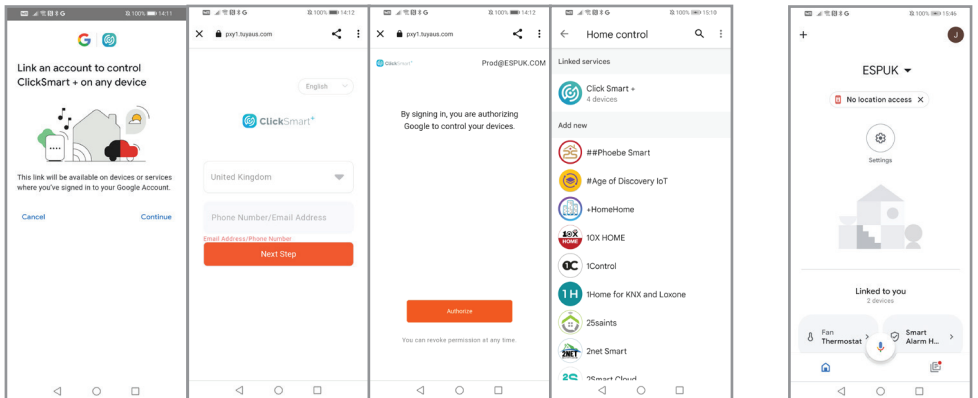

5. The Google Home app will then take you through the Account Binding Process, you must use the ClickSmart+ Account you used to pair your ECPST

6. Google Home will now contain all compatible Click Smart + products.

Voice Commands

After waking up the Alexa device or Google Home/Assistant Device, you can use the below voice commands:

Amazon Alexa

Turn On <DEVICE NAME>
Turn Off <DEVICE NAME>
What is the temperature of <DEVICE NAME>
Make it warmer in <DEVICE NAME>
Make it cooler in <DEVICE NAME>
Set <DEVICE NAME> to <NUMBER VALUE>

Google Home/Assistant

Turn On <DEVICE NAME>
Turn Off <DEVICE NAME>
Set <DEVICE NAME> to <NUMBER VALUE>

Notes



Elite Security Products

Unit 7, Target Park, Shawbank Rd
Lakeside, Redditch B98 8YN



● ● ● ● ● **Scolmore**GROUP

www.espuk.com

E&OE - Errors and Omissions
Excepted. K23

Telephone: 01527 51 51 50
Fax: 01527 51 51 43
email: sales@espuk.com