

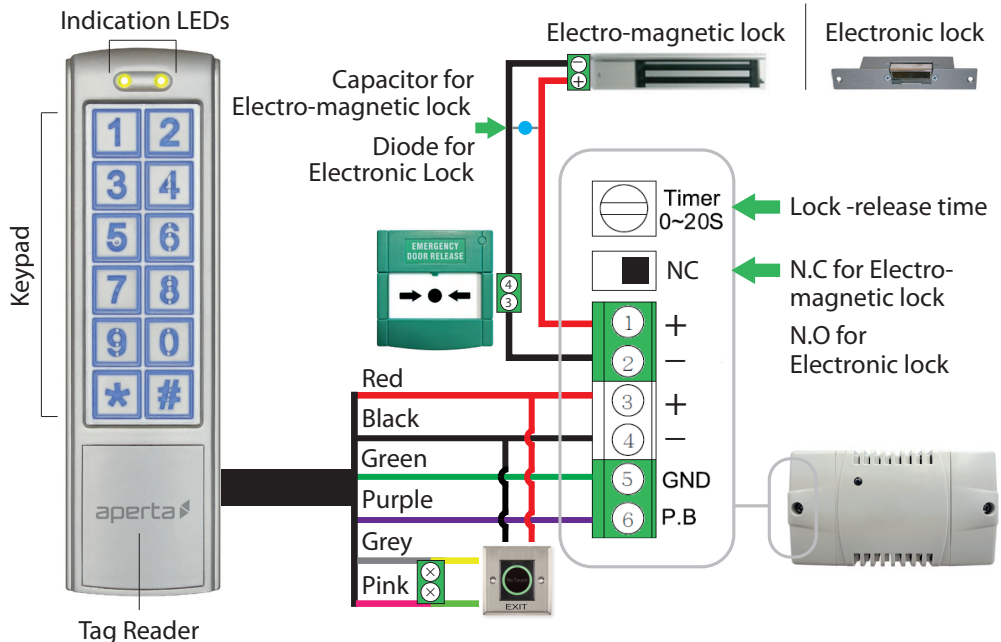









## Step 1 - Wiring

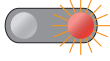

## Step 2 - Setting Access Pin Number

Step Number	Action	Keypad Indication
1	1 2 3 4 1 2 3 4	Long Tone
2	* 9	Long Tone
3	0 2	Long Tone
4	0 0 0	Double Tone
5	? ? ? ? Enter a 4 digit pin (1234 not to be used)	Long Tone
6	# # To end programming	Green Light

## Step 3 - Registering 10 Tags

Step Number	Action	Keypad Indication
1	1 2 3 4 1 2 3 4	 Long Tone
2	* 9	
3	0 5	 Long Tone
4	0 0 1	 Long Tone
5	0 1 0	 Tone
6	 Present the tag with the lowest serial number	 Tone
7	All other batch tags will auto register   To end programming	

## Step 4 - Release Lock

(A) Enter a programmed Access Pin number

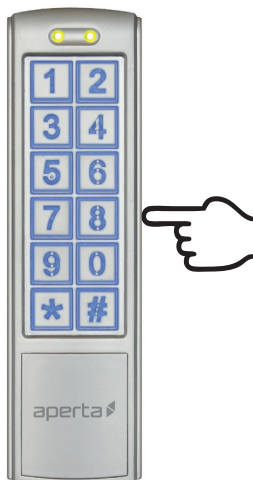

(B) Present a registered Tag

