

aperta

APKITKBLK | COLOUR VIDEO DOOR ENTRY SYSTEM



USER MANUAL



www.espuk.com



Contents

System Components	3
Installation	4
System Connections Example 1.....	5
System Connections Example 2.....	6
Lock Connections Example 1	7
Lock Connections Example 2	7
Door Station Programming Guide	8
User Guide	10
Installer's Guide	11

System Cabling

All system cabling (excluding mains 240vAC supply) has been tested with Cat5E UTP PVC cable.



Part Number - A8NFORCE5EUTP

Find this product online:
elandcables.com | Cables & Accessories | LAN Cable | Cat 5E UTP PVC Cable





System Components



Door Station

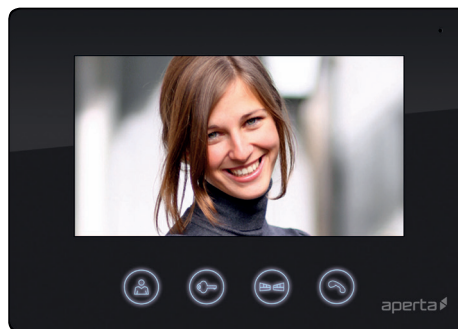

Monitor



System Power Supply

Optional Accessories



EVBPSBB
Lock Power Supply



EV-EXIT
Push To Release



EV-EBG
Emergency Release



EV-ML-250/500XT
Electro-magnetic Lock



ENTERD
Electric Lock





Installation



Site the door station a recommended 1.5 meters from the ground, or to suit application.

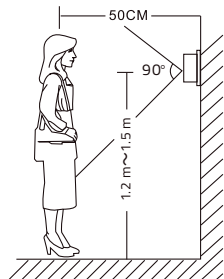

The camera needs to point in the direction of where a visitor will stand during operation.

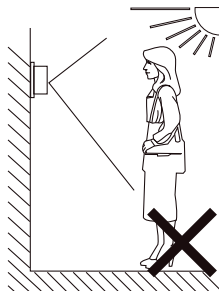

Avoid areas of high sunlight and noise levels.

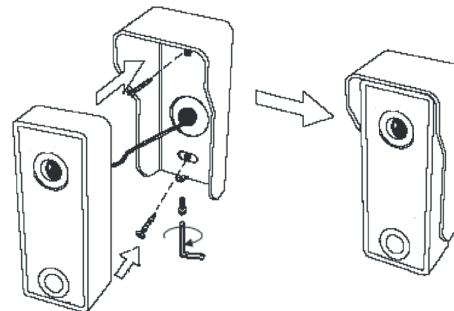

Surface mount the sunshield of the door station and connect the system cabling. Mount the camera to the sunshield by fixing with the supplied hex screw.

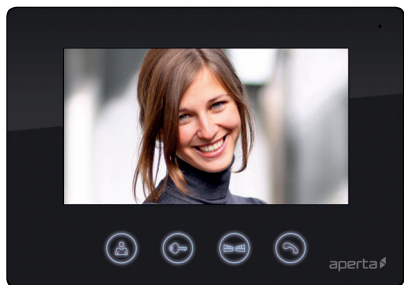

Site the indoor monitor to suit application.

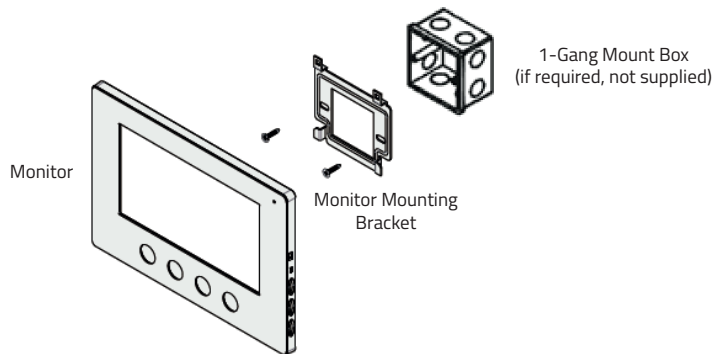

Surface mount the bracket of the monitor or if required onto a 1-gang mount box (not supplied). Make the system connections to the back of the monitor and then slide the monitor onto the bracket using the hooks to hold firmly in place.





System Connections Example 1

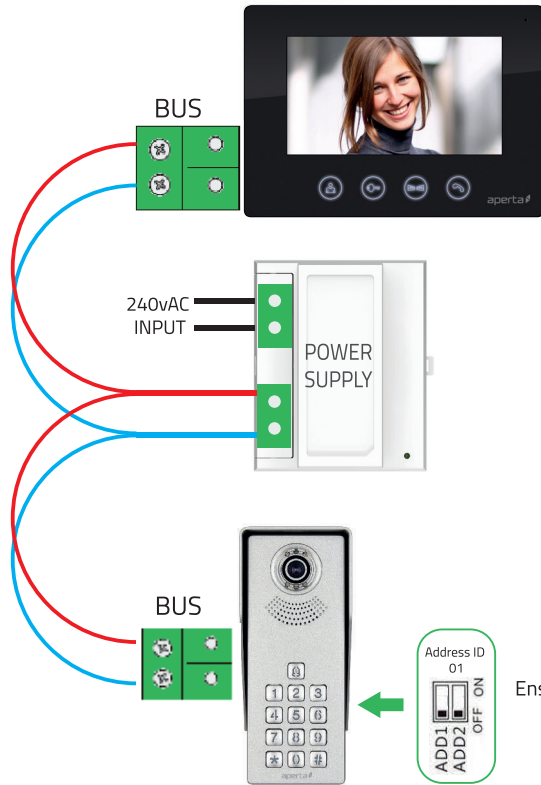

Dip switch 6 set to ON when device is at the end of system line.
 Dip switch 7 set to OFF to select monitor as the 'Master'
 Only one monitor on the system can be the 'Master'

Total cable run should not exceed 150 meters between door station and monitor

Power supply to be with-in 100 meters of monitor

No cable or connection polarity

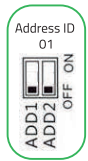

Ensure the Address ID switches are both set to OFF

System Connections Example 2

The system power supply can support up to 5 devices

Total cable run should not exceed 150 meters between door station and monitor



Power supply to be within 100 meters of monitor



No cable or connection polarity



- 1 Only one monitor is set as the MASTER:

MASTER=
ON
7
OFF

- 2 All other monitors set as SLAVE:

SLAVE=
ON
7
OFF

- 3 Last monitor on system line has dip switch 6 set to ON

END OF LINE=
ON
6
OFF

- 4 When using different style monitors on the same system, please refer to supplied instruction to configure Master, Slave and End of line position.

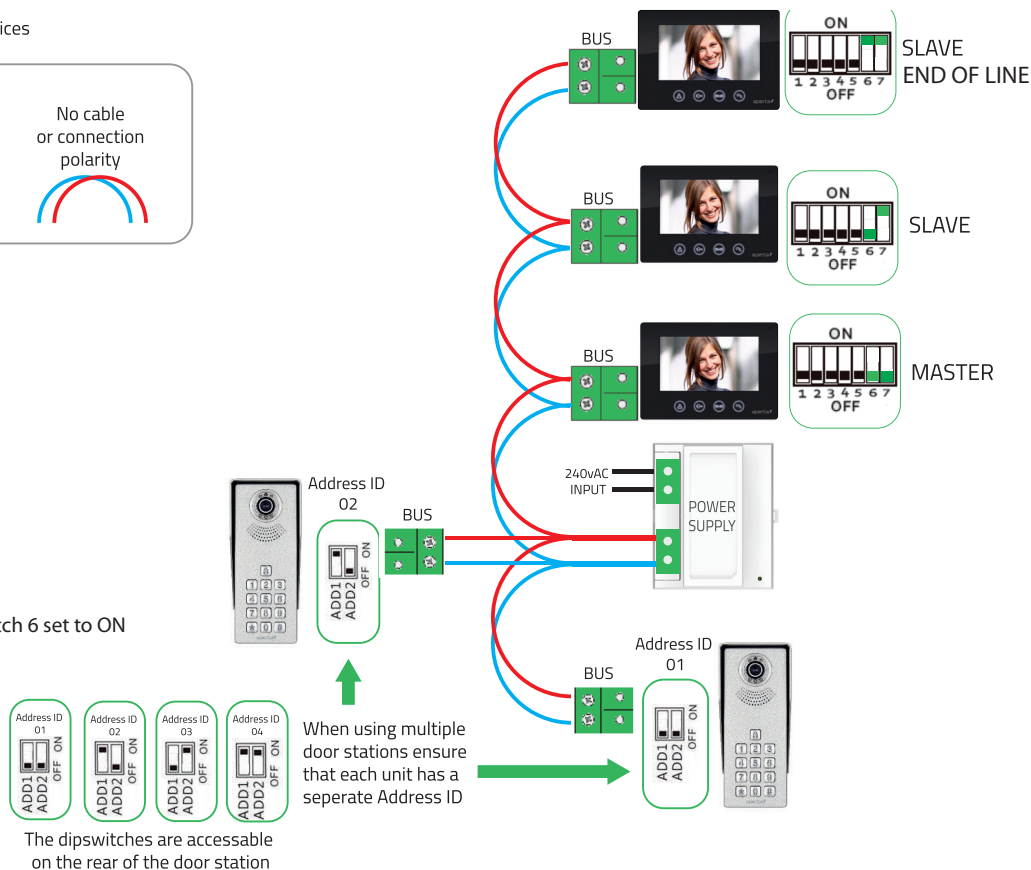

Lock Connections Example 1

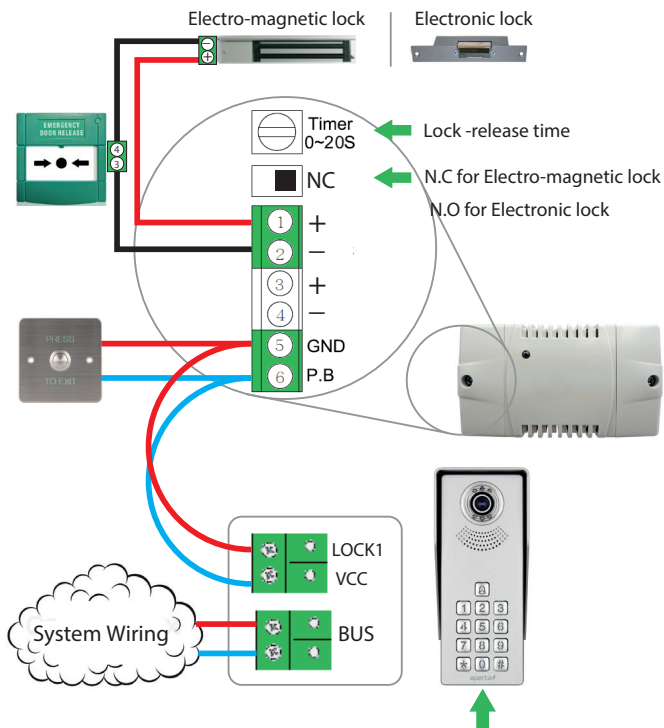

At the rear of the door station ensure that the jumper links cover pins 1 and 2, on both J3 and J2 positions

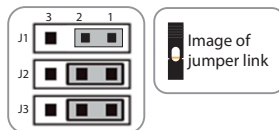

Lock Connections Example 2

- The jumpers on the rear of the door station offer different types of release modes for alternative applications dependent on the jumper link settings. LOCK1 options;
- The door station has a secondary switch. LOCK2 options;

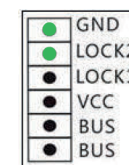
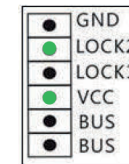
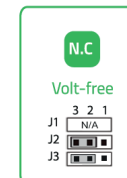
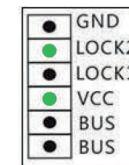
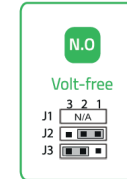
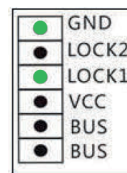
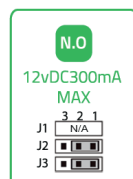
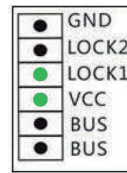
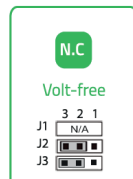
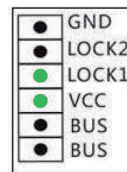
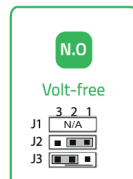

- Please refer to the operation guide for release instructions

Door Station Programming Guide

Entering Administration Mode

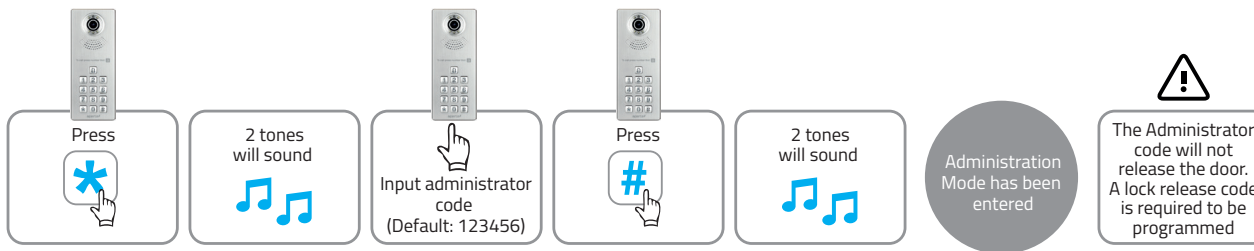

Setting a lock release code

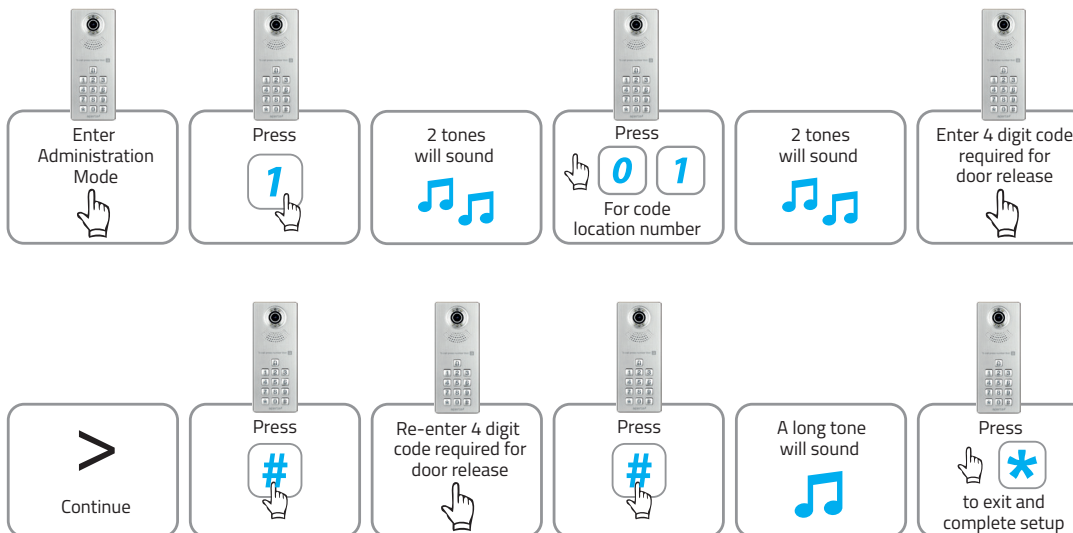



Deleting a lock release code

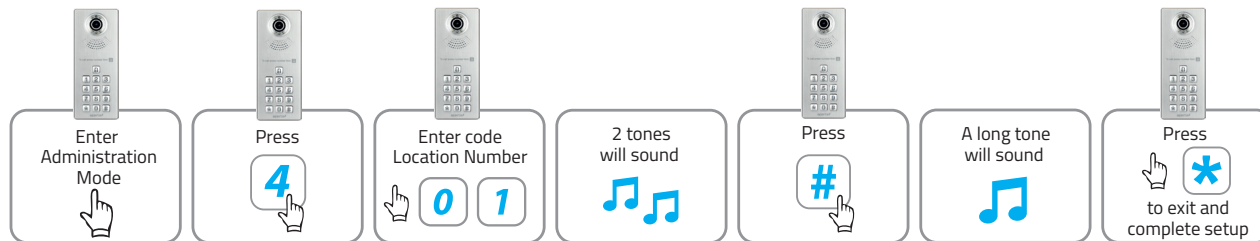

Changing the Administrator code



User Guide







Preview
Press once to view door station image



Lock
Press once to release lock



Gate
Press once to release lock 2



Talk
Press once to talk to visitor

- Chime Volume: Slide switch for High, Medium and Low setting
- Chime Selection: Press button to select chime melody
- Monitor Brightness: Adjustment for brightness levels
- Monitor Chroma: Adjustment for the intensity of colour
- Talking Volume: Adjust the volume level of the monitor

A
B
C
D



The visitor presses the call button



A chime will sound



The visitor's image will appear on the monitor



Press the 'Talk' button and begin conversation

Then choose between these 3 options



Press the 'Talk' button to end call



Press the 'Lock' button to release lock and press 'Talk' to end call



Press the 'Gate' button to release lock 2 and press 'Talk' to end call

Using the lock release code



Enter 4 digit lock release code



Press #



The lock will release



Installer's Guide

Master / Slave Setting

When using multiple monitors on 1 system;
Only the 1 handset set as the MASTER will display an image when the door station is activated.
All other monitors will ring, and will display the image once the 'Talk' button is pressed.

In the event of no video or audio signals coming from the monitor, or if the call button or audio cannot be activated on the door station, check the following;

- A That the system is powered sufficiently.
- B Each monitor needs to be set to a MASTER or SLAVE position
- C All system cabling is secured and properly connected.
- D All system cabling is clear of breaks or short circuits.
- E Bench test the system if the issue cannot be found.

In the event of a lock release issue, check the following;

- A The user instructions and operation of the monitor has been understood.
- B That the lock is powered sufficiently.
- C All system cabling is secured and properly connected.
- D All system cabling is clear of breaks or short circuits.
- E On the rear of the door station, ensure the lock output is switching when activated by the monitor.



Elite Security Products
Unit 7, Target Park, Shawbank Rd
Lakeside, Redditch B98 8YN



Telephone: 01527 51 51 50
Fax: 01527 51 51 43
email: info@espuk.com

E&OE - Errors and omissions excepted. D17

www.espuk.com

